

X2Y

®



Technology In Balance

JOHANSON
DIELECTRICS 

X2Y[®] for Today's Circuits

Circuit designers today are challenged with maintaining Signal and Power Integrity amid increasing Electro-Magnetic Compliance (EMC) requirements, while at the same time lowering system costs. X2Y[®] Technology is an enabler to this end, providing a quantum leap in circuit performance. X2Y[®] replaces multiple standard passives and Integrated Passive Components with a single device, freeing precious board space for additional active components or design miniaturization. In short, X2Y[®] gives end-users the cost advantage they need to compete in today's market.

X2Y[®] Technology Overview

X2Y[®] components share many common traits with conventional multi-layer ceramic capacitors (MLCC) to facilitate adoption by end-users into their manufacturing processes

- Same component sizes (0603, 0805, 1206, etc.)
- Same pick and place equipment
- Same voltage ratings
- Same dielectric, electrode and termination materials
- Same industry test standards for component reliability



The X2Y[®] design - A Capacitive Circuit

A standard bypass capacitor has opposing electrode layers stacked inside. An X2Y[®] adds another set of electrode layers to effectively surround each existing electrode within the stack of a two-terminal capacitor. The only external difference is two additional side terminations, creating a four-terminal capacitive circuit, which allows circuit designers a multitude of attachment options.

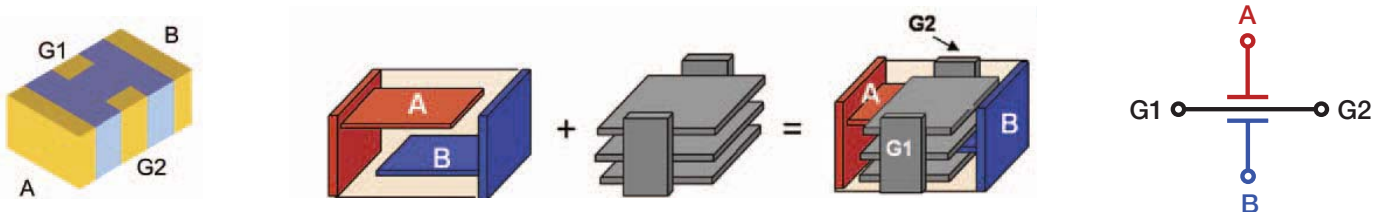

X2Y[®] Circuit 1: Filtering

When used in circuit 1 configuration the X2Y[®] filter capacitor is connected across two signal lines. Differential mode noise is filtered to ground by the two Y capacitors, A & B. Common mode noise is cancelled within the device.

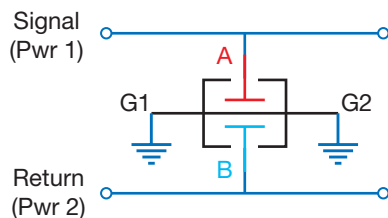

X2Y[®] Circuit 2: Decoupling

When used in circuit 2 configuration A & B capacitors are placed in parallel effectively doubling the apparent capacitance while maintaining an ultra-low inductance.

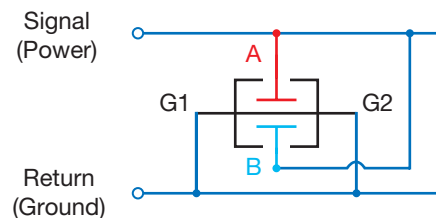

EMI Filtering with X2Y®

Many experts agree that balance is the key to a “quiet” circuit. X2Y® is a balanced circuit device with two equal halves, tightly matched in both phase and magnitude with respect to ground. This effectively eliminates the need for a common mode choke*. Several advantages are gained by two balanced capacitors sharing a single ceramic component body.

- Exceptional common mode rejection
- Effects of aging & temperature are equal on both caps
- Effect of voltage variation eliminated
- Matched line-to-ground capacitance

InAmp Input Filter Example

In this example, a single Johanson X2Y® component was used to filter noise at the input of a DC instrumentation amplifier. This reduced component count by 3-to-1 and costs by over 70% vs. conventional filter components that included 1% film Y-capacitors.

Parameter	X2Y® 10nF	Discrete 10nF, 2 @ 220 pF	Comments
DC offset shift	< 0.1 μ V	< 0.1 μ V	Referred to input
Common mode rejection	91 dB	92 dB	

Source: Analog Devices, “A Designer’s Guide to Instrumentation Amplifiers (2nd Edition)” by Charles Kitchin and Lew Counts

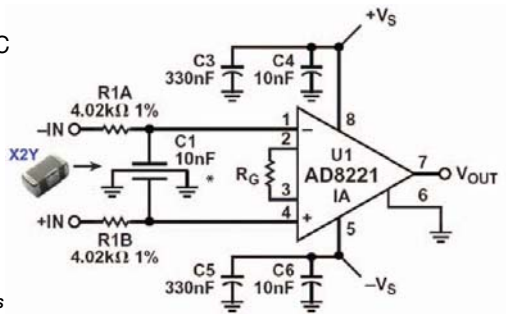

Common Mode Choke Replacement

In this example, a 5 μ H common mode choke is replaced by an 0805, 1000pF X2Y® component achieving superior EMI filtering by a component a fraction of the size and cost.

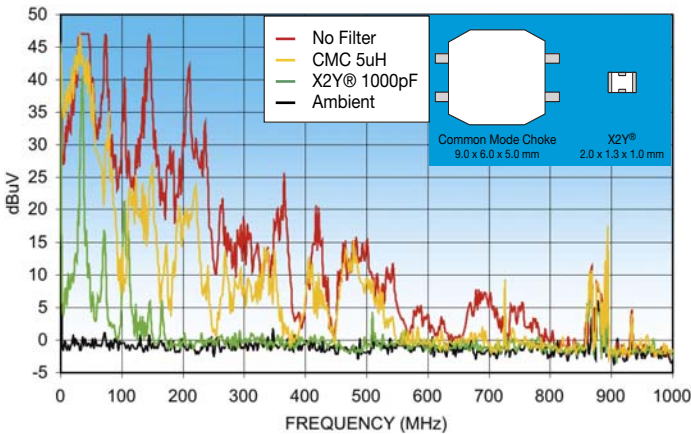

DC Motor EMI Reduction: A Superior Solution

One X2Y® component has successfully replaced 7 discrete filter components while achieving superior EMI filtering.

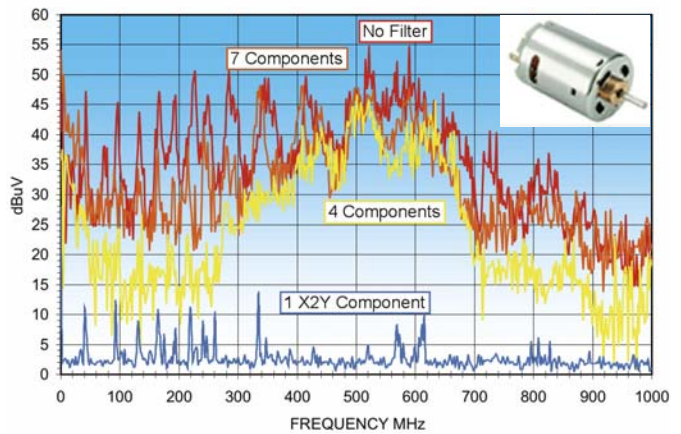

Signal Line Filter for USB & RJ45

One X2Y® component can effectively filter high speed signal lines replacing multiple inductive and ferrite components.

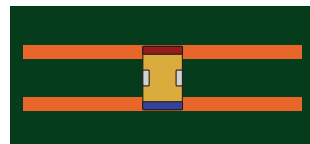

Signal lines filtered with X2Y®

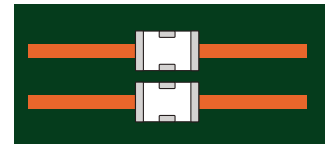

Signal lines filtered with LC Filter Chip

Other X2Y® Filter Applications

DC-DC converters, power I/O, connectors (RJ45, D-sub), audio/voice/data, CAN, high-speed differential. Effectively replaces common mode chokes, inductors, ferrites and feedthru capacitors.



Decoupling with X2Y®

The low inductance advantages of the X2Y® Capacitor Circuit enables high-performance bypass networks at reduced system cost.

- Low ESL (device only and mounted)
- Broadband performance
- Effective on PCB or package
- Lower via count, improves routing
- Reduces component count
- Lowers placement cost

Component Performance

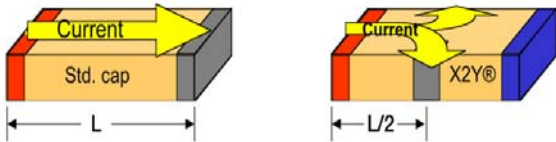

The X2Y® has short, multiple and opposing current paths resulting in lower device inductance.

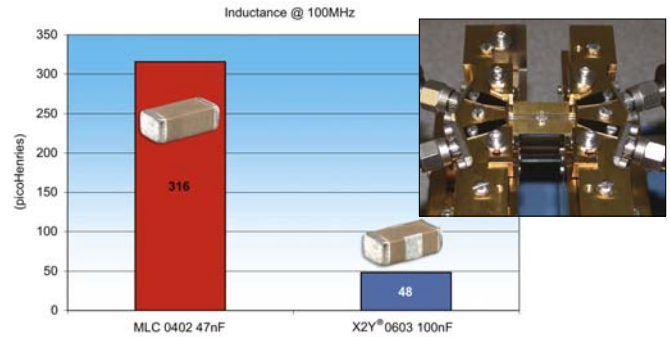

Mounted Performance

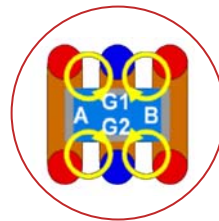
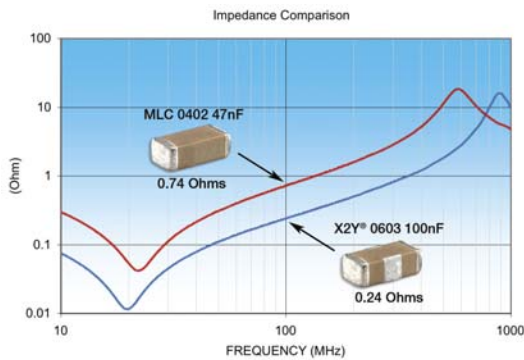

Mutual coupling from opposing polarity vias lowers inductance when mounted on a PCB.

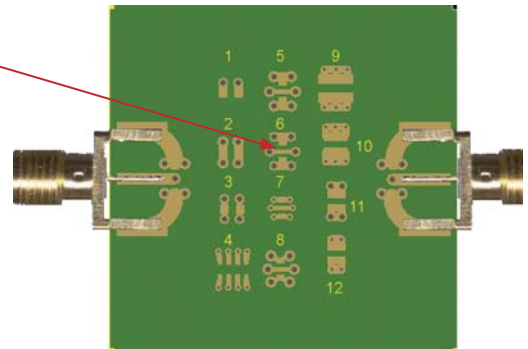

SYSTEM PERFORMANCE

1:5 MLCC Replacement Example

X2Y's® proven technology enables end-users to use one X2Y capacitor to replace five conventional MLCCs in a typical high performance IC bypass design. Vias are nearly cut in half, board space is reduced and savings are in dollars per PCB.

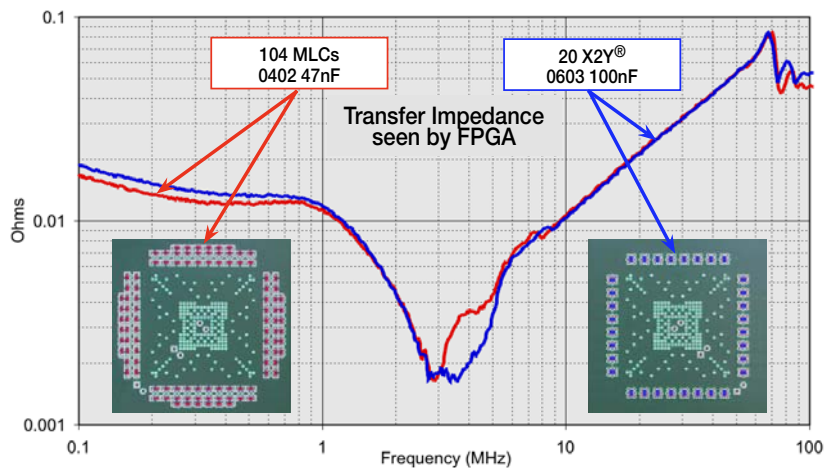

X2Y® FILTER & DECOUPLING CAPACITORS

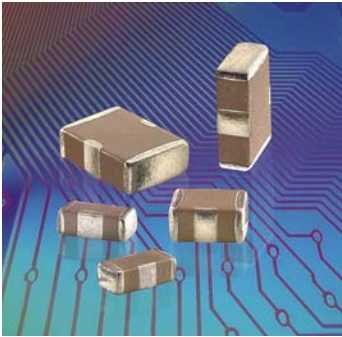

X2Y® filter capacitors employ a unique, patented low inductance design featuring two balanced capacitors that are immune to temperature, voltage and aging performance differences.

These components offer superior decoupling and EMI filtering performance, virtually eliminate parasitics, and can replace multiple capacitors and inductors saving board space and reducing assembly costs.

ADVANTAGES

- One device for EMI suppression or decoupling
- Replace up to 7 components with one X2Y
- Differential and common mode attenuation
- Matched capacitance line to ground, both lines
- Low inductance due to cancellation effect

APPLICATIONS

- FPGA / ASIC / μ -P Decoupling
- DDR Memory Decoupling
- Amplifier Filter & Decoupling
- High Speed Data Filtering
- Cellular Handsets

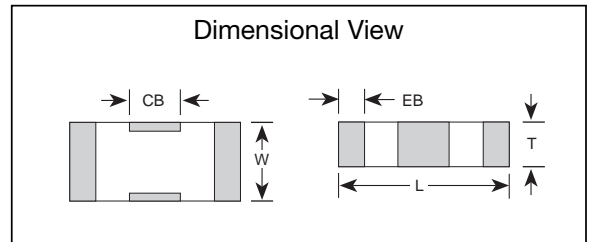
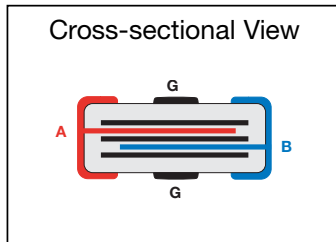
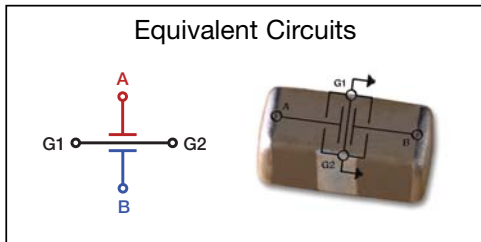

SIZE EIA (JDI)	Circuit 1 (Y Cap.)		1.0pF	5.6pF	10pF	22pF	27pF	33pF	47pF	100pF	220pF	470pF	1000pF	1500pF	2200pF	4700pF	.010mF	.022mF	.047mF	.10mF	.12mF	.22mF	.33mF	.40mF	.47mF	.56mF	.68mF				
	Circuit 2 (2*Y Cap.)		2.0pF	11.2pF	20pF	44pF	54pF	66pF	94pF	200pF	440pF	940pF	2000pF	3000pF	4400pF	9400pF	.020mF	.044mF	.094mF	0.20mF	0.24mF	0.44mF	0.68mF	0.80mF	0.94mF	1.12mF	1.36mF				
	Order Code	1R0	5R6	100	220	270	330	470	101	221	471	102	152	222	472	103	223	473	104	124	224	334	404	474	564	684					
0402 X07	X7R	50																													
		6.3																													
0603 X14	NPO	50																													
		25																													
	X7R	50																													
		6.3																													
0805 X15	NPO	100																													
		50																													
	X7R	100																													
		50																													
1206 X18	NPO	50																													
		100																													
	X7R	50																													
100																															
1210 X41	X7R	100																													
		50																													
1410 X44	X7R	100																													
		50																													
1812 X43	X7R	100																													
		50																													

 = RoHS NPO
 = RoHS X7R
 * = Non-RoHS X7R

Circuit 1 (Balanced Filtering) = A (or B) to G Circuit 2 (Decoupling) = A + B to G [A to B capacitance = 1/2 C1]
 Rated voltage is for A or B to ground. A to B rating is 2 X Vrated Contact the factory for other voltage ratings and capacitance values.

X2Y® technology patents and registered trademark under license from X2Y ATTENUATORS, LLC

X2Y® FILTER & DECOUPLING CAPACITORS

Filtering Circuit 1 S21 Signal-to-Ground

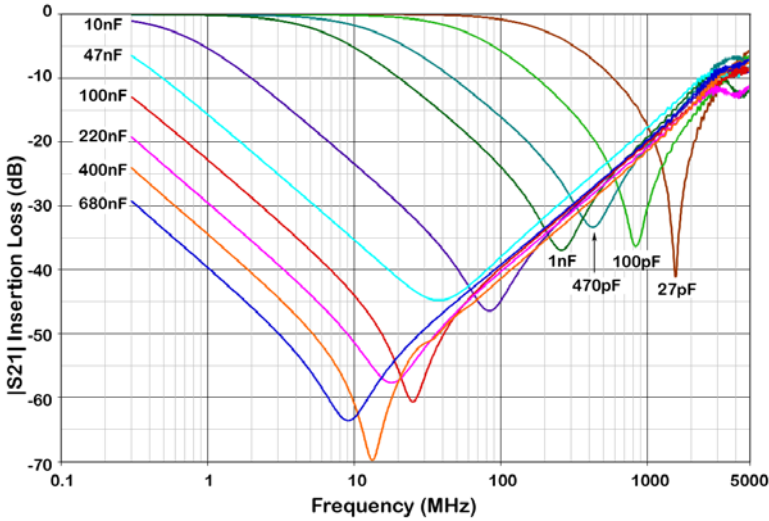
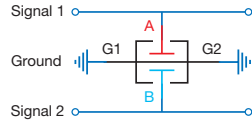

Decoupling Circuit 2 S21 Power-to-Ground

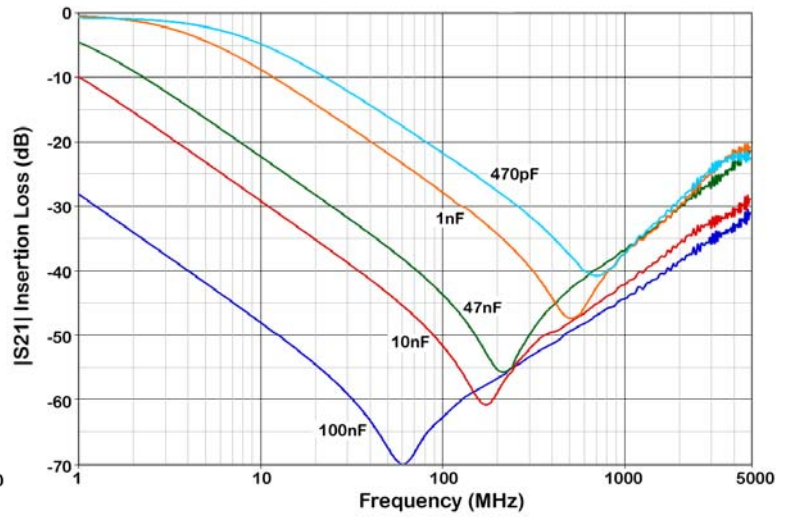
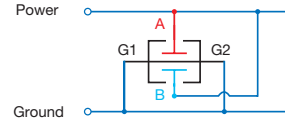

Additional test data and related information available at www.johansondielectrics.com/x2y/

MECHANICAL CHARACTERISTICS

	0402 (X07)		0603 (X14)		0805 (X15)		1206 (X18)		1210 (X41)		1410 (X44)		1812 (X43)	
	IN	mm	IN	mm	IN	mm	IN	mm	IN	mm	IN	mm	IN	mm
L	0.045 ± 0.003	1.143 ± 0.076	0.064 ± 0.005	1.626 ± 0.127	0.080 ± 0.008	2.032 ± 0.203	0.124 ± 0.010	3.150 ± 0.254	0.125 ± 0.010	3.175 ± 0.254	0.140 ± 0.010	3.556 ± 0.254	0.174 ± 0.010	4.420 ± 0.254
W	0.024 ± 0.003	0.610 ± 0.076	0.035 ± 0.005	0.889 ± 0.127	0.050 ± 0.008	1.270 ± 0.203	0.063 ± 0.010	1.600 ± 0.254	0.098 ± 0.010	2.489 ± 0.254	0.098 ± 0.010	2.490 ± 0.254	0.125 ± 0.010	3.175 ± 0.254
T	0.020 max	0.508 max	0.026 max	0.660 max	0.040 max	1.016 max	0.050 max	1.270 max	0.070 max	1.778 max	0.070 max	1.778 max	0.090 max	2.286 max
EB	0.008 ± 0.003	0.203 ± 0.076	0.009 ± 0.004	0.229 ± 0.102	0.009 ± 0.004	0.229 ± 0.102	0.009 ± 0.004	0.229 ± 0.102	0.009 ± 0.005	0.229 ± 0.127	0.009 ± 0.005	0.229 ± 0.127	0.009 ± 0.005	0.229 ± 0.127
CB	0.010 ± 0.003	0.305 ± 0.076	0.018 ± 0.004	0.457 ± 0.102	0.022 ± 0.005	0.559 ± 0.127	0.040 ± 0.005	1.016 ± 0.127	0.045 ± 0.005	1.143 ± 0.127	0.045 ± 0.005	1.143 ± 0.127	0.045 ± 0.005	1.143 ± 0.127

HOW TO ORDER X2Y® EMI FILTER CAPACITORS

500	X18	W	473	M	V	4	E
VOLTAGE 6R3 = 6.3 V 250 = 25 V 500 = 50 V 101 = 100 V	CASE SIZE X07 = 0402 X14 = 0603 X15 = 0805 X18 = 1206 X41 = 1210 X43 = 1812 X44 = 1410	DIELECTRIC N = NPO W = X7R	CAPACITANCE 1st two digits are significant; third digit denotes number of zeros. 474 = 0.47 µF 105 = 1.00 µF	TOLERANCE M = ± 20%	TERMINATION V = Ni barrier w/ 100% Sn Plating	MARKING 4 = Unmarked	TAPE MODIFIER Code Tape Reel E Embossed 7" U Embossed 13" T Paper 7" R Paper 13" Tape specs. per EIA RS481

P/N written: 500X18W473MV4E



X2Y® FILTER & DECOUPLING CAPACITORS

SOLDER PAD RECOMMENDATIONS

	0402 (X07)		0603 (X14)		0805 (X15)		1206 (X18)		1210 (X41)		1410 (X44)		1812 (X43)	
	IN	mm	IN	mm	IN	mm	IN	mm	IN	mm	IN	mm	IN	mm
X	0.020	0.51	0.035	0.89	0.050	1.27	0.065	1.65	0.100	2.54	0.100	2.54	0.125	3.18
Y	0.020	0.51	0.025	0.64	0.035	0.89	0.040	1.02	0.040	1.02	0.040	1.02	0.040	1.02
G	0.024	0.61	0.040	1.02	0.050	1.27	0.080	2.03	0.080	2.03	0.100	2.54	0.130	3.30
V	0.015	0.38	0.020	0.51	0.022	0.56	0.040	1.02	0.045	1.14	0.045	1.14	0.045	1.14
U	0.039	0.99	0.060	1.52	0.080	2.03	0.120	3.05	0.160	4.06	0.160	4.06	0.190	4.83
Z	0.064	1.63	0.090	2.29	0.120	3.05	0.160	4.06	0.160	4.06	0.180	4.57	0.210	5.33

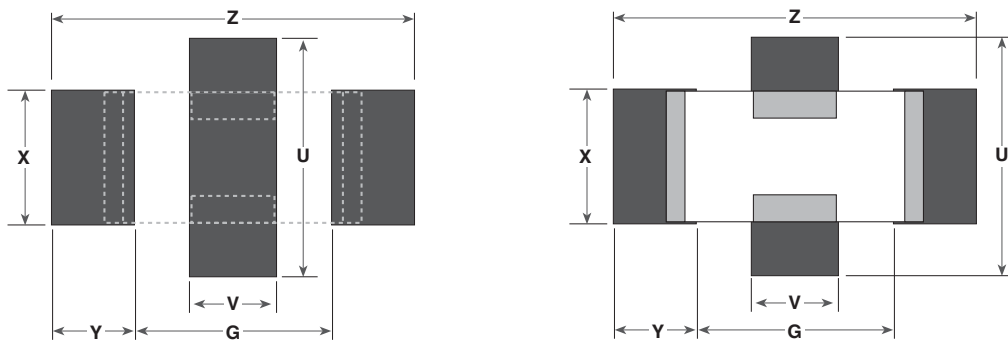

Use of solder mask beneath component is not recommended.

OPTIMIZING X2Y PERFORMANCE WITH PROPER ATTACHMENT TECHNIQUES

X2Y® capacitors excel in low inductance performance for a myriad of applications including EMI/RFI filtering, power supply bypass / decoupling. How the capacitor is attached to the application PCB is every bit as important as the capacitor itself. Proper attention to pad layout and via placement insures superior device performance. Poor PCB layouts squander performance, requiring more capacitors, and more vias to do the same job. Figure 1 compares the X2Y® recommended layout against a poor layout. Because of its long extents from device terminals to vias, and the wide via separation, the poor layout shown performs badly. It exhibits approximately 200% L1 inductance, and 150% L2 inductance compared to recommended X2Y® layouts.

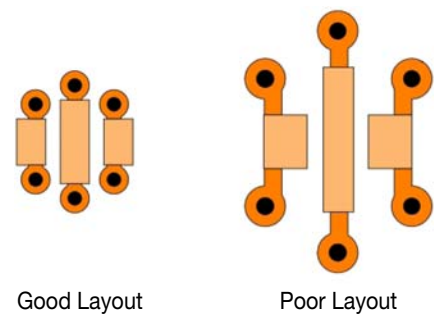

Figure 1

For further details on via placement and its effect on mounted inductance, please refer to X2Y Attenuators, LLC. application note #3008 "Get the Most from X2Y Capacitors with Proper Attachment Techniques" at www.x2y.com

Johanson Dielectrics, Inc. reserves the right to make design and price changes without notice. All sales are subject to the terms and conditions printed on the back side of our sales order acknowledgment forms, including a limited warranty and remedies for non-conforming goods or defective goods. We will be pleased to provide a copy of these terms and conditions for your review.



JOHANSON DIELECTRICS, INC.

SYLMAR, CALIFORNIA

www.johansondielectrics.com



*Surface Mount
Ceramic Capacitors*



*High Voltage
Ceramic Capacitors*

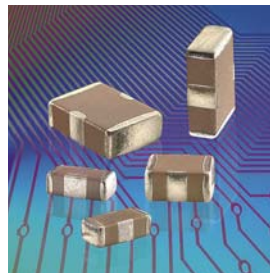

*X2Y®
EMI Filter Capacitors*

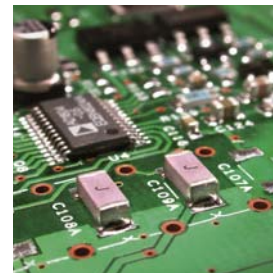

*Y1 & Y2 Safety
Certified Capacitors*

JOHANSON TECHNOLOGY, INC.

CAMARILLO, CALIFORNIA

www.johansontechnology.com



*High Frequency
Capacitors & Inductors*



*900 MHz - 6.0 GHz
Ceramic Components*

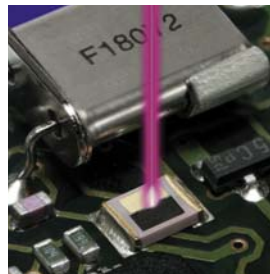

*LASERtrim®
Tuning Capacitors*

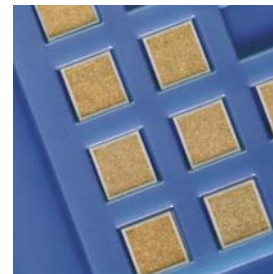

*Single Layer
Microwave Capacitors*

ADVANCED MONOLYTHIC CERAMICS

OLEAN, NEW YORK

www.amccaps.com



*Ceramic Planar
Array Filters*

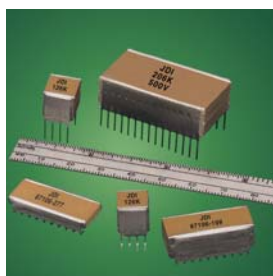

*Switchmode
Ceramic Capacitors*



*Radial Led
High Voltage MLCCs*

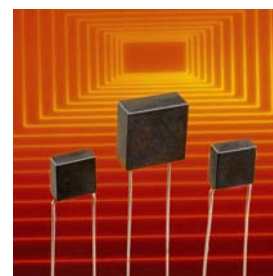

*High Temperature
Radial Led MLCCs*



15191 Bledsoe St., Sylmar, California 91342
TEL (818) 364-9800 • FAX (818) 364-6100
<http://www.johansondielectrics.com>